

REQUIRED CONCRETE PAD

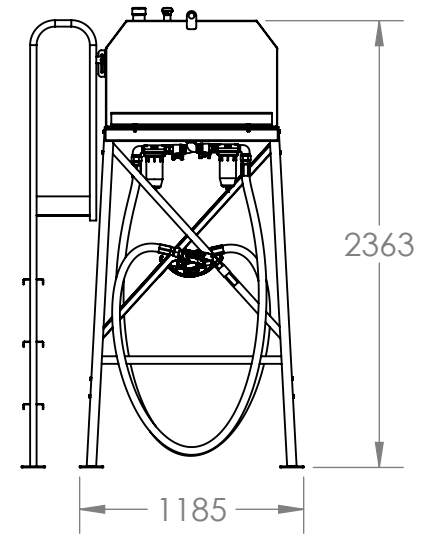

NOTES / AMENDMENTS:

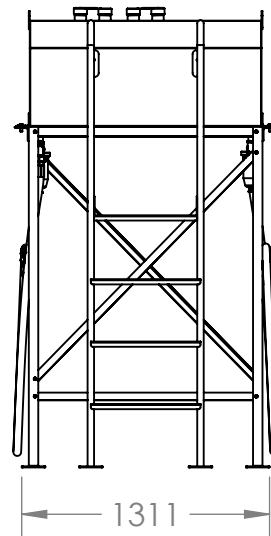
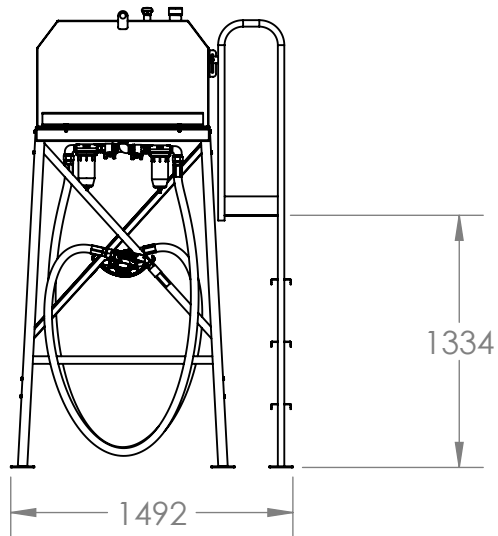
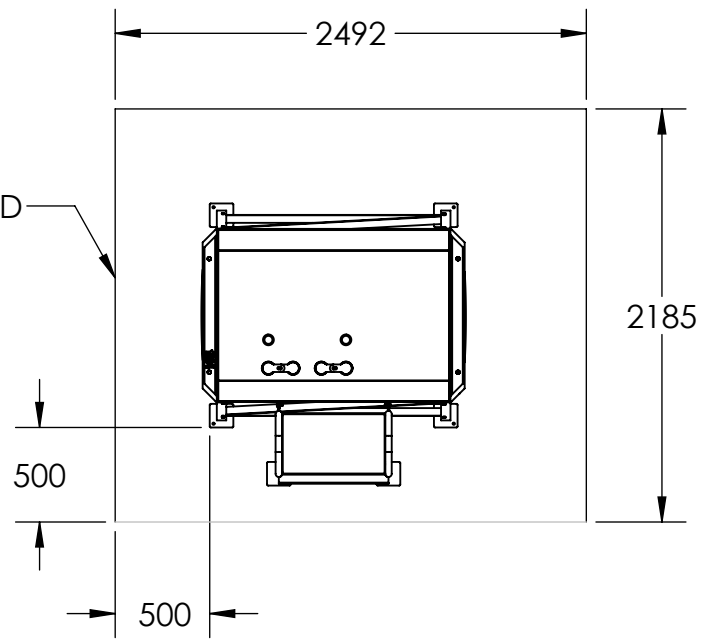

DRAWING NO:	FSL 600 OVER HEAD SPLIT TANK		
SCALE:	1:40	SHEET NO:	1
DIMENSIONS:	MM	ISSUE DATE:	28/10/2020
DRAWN BY:	BAZ		A4